

ACCESS, ACCESS TILE, ACCESS AND THE THREE AND TWO DIMENSIONAL DESIGNS ON THE TILE BETWEEN DOMES AND ON DOMES ARE TRADEMARKS OF ENGINEERED SYSTEMS INC. PATENTS PENDING IN THE UNITED STATES, CANADA AND INTERNATIONALLY MANUFACTURED AND DISTRIBUTED UNDER LICENSE BY ACCESS WORLD PRODUCTS INCORPORATED

© KENNETH E. SZEKELY

MATERIAL LIST

ITEM	DESCRIPTION	PART NO.	QTY
1	ACCESS TILE	ACA-S-36-xx	1
2	ACCESS ANCHOR	AC-640-xx	8

REFERENCE DRAWINGS

DWG. NO.	DESCRIPTION

No.	DATE	REVISION	APPR.

SCALE 1"=1'-0" U.N.O. FULL SIZE ONLY

DESIGNED	BY	DATE
	KES	02/09/2009
DRAWN		
	ZQ	02/09/2009
CHECKED		

TOLERANCE ±0.06

TRADE DETECTABLE WARNING SURFACE

MATERIAL VITRIFIED POLYMER COMPOSITE

SUBJECT **ACCESS TILE®**
TACTILE WARNING TILE

PROJECT **ACCESS TILE®**
TACTILE WARNING TILE
300X600 SURFACE APPLIED SYSTEM

DRAWING NO. ACA-S-36 REV. NO. ∅

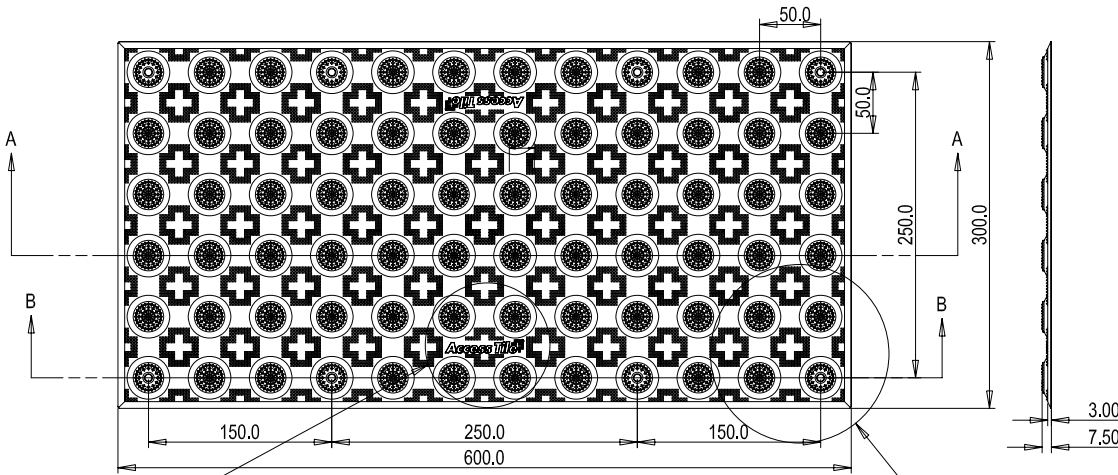

SEE DETAIL F

SEE DETAIL E

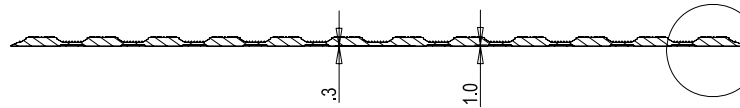

SECTION A-A

SEE DETAIL C

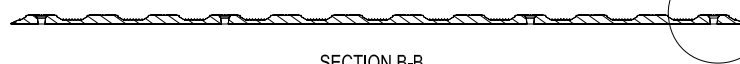

SECTION B-B

SEE DETAIL D

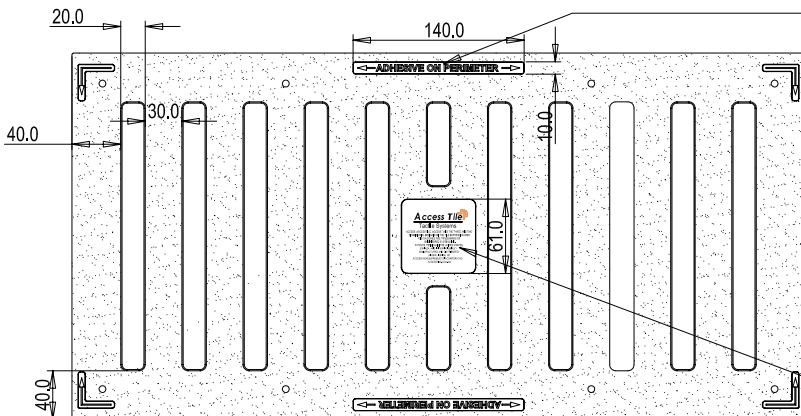

TEXT AND ARROW MARK HIGH NO MORE THAN 0.3MM, TEXT STYLE IS ARIAL BOLD TEXTURING NUMBERYS20001

IP MARK HIGH NO MORE THAN 0.3MM

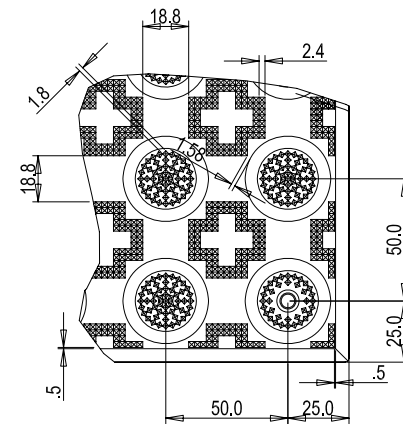

DETAIL E SCALE 2

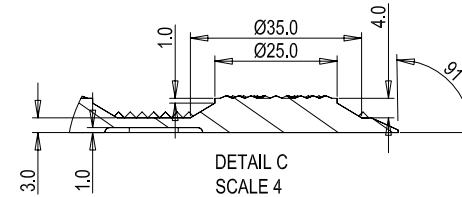

DETAIL C SCALE 4

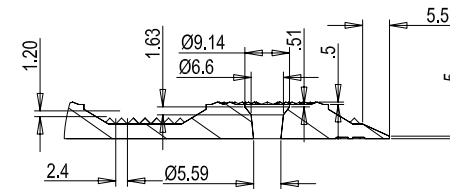

DETAIL D SCALE 4

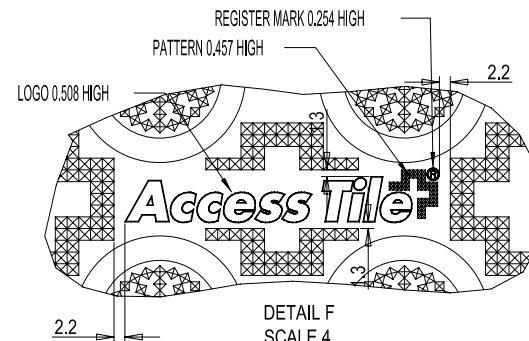

DETAIL F SCALE 4